



Is Now Part of



ON Semiconductor®

To learn more about ON Semiconductor, please visit our website at
www.onsemi.com

ON Semiconductor and the ON Semiconductor logo are trademarks of Semiconductor Components Industries, LLC dba ON Semiconductor or its subsidiaries in the United States and/or other countries. ON Semiconductor owns the rights to a number of patents, trademarks, copyrights, trade secrets, and other intellectual property. A listing of ON Semiconductor's product/patent coverage may be accessed at www.onsemi.com/site/pdf/Patent-Marking.pdf. ON Semiconductor reserves the right to make changes without further notice to any products herein. ON Semiconductor makes no warranty, representation or guarantee regarding the suitability of its products for any particular purpose, nor does ON Semiconductor assume any liability arising out of the application or use of any product or circuit, and specifically disclaims any and all liability, including without limitation special, consequential or incidental damages. Buyer is responsible for its products and applications using ON Semiconductor products, including compliance with all laws, regulations and safety requirements or standards, regardless of any support or applications information provided by ON Semiconductor. "Typical" parameters which may be provided in ON Semiconductor data sheets and/or specifications can and do vary in different applications and actual performance may vary over time. All operating parameters, including "Typicals" must be validated for each customer application by customer's technical experts. ON Semiconductor does not convey any license under its patent rights nor the rights of others. ON Semiconductor products are not designed, intended, or authorized for use as a critical component in life support systems or any FDA Class 3 medical devices or medical devices with a same or similar classification in a foreign jurisdiction or any devices intended for implantation in the human body. Should Buyer purchase or use ON Semiconductor products for any such unintended or unauthorized application, Buyer shall indemnify and hold ON Semiconductor and its officers, employees, subsidiaries, affiliates, and distributors harmless against all claims, costs, damages, and expenses, and reasonable attorney fees arising out of, directly or indirectly, any claim of personal injury or death associated with such unintended or unauthorized use, even if such claim alleges that ON Semiconductor was negligent regarding the design or manufacture of the part. ON Semiconductor is an Equal Opportunity/Affirmative Action Employer. This literature is subject to all applicable copyright laws and is not for resale in any manner.



FPF2G120BF07ASP

F2, 3ch Boost module PCM and NTC

General Description

The FPF2G120BF07ASP is the 3ch boost topology which is providing an optimized solution for the multi-string solar application. And the integrated high speed field stop IGBTs and SiC diodes are providing lower conduction and switching losses. And the pre-applied PCM requires no additional process of the thermal interface material printing. Furthermore, the screw clamp provides a fast and reliable mounting method.

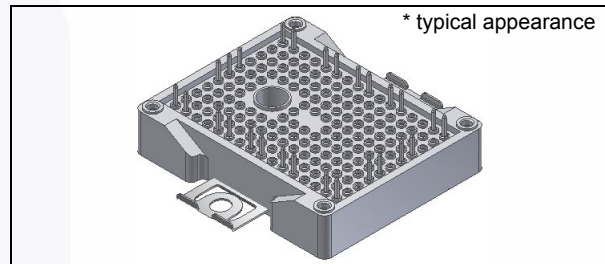

Package Code: F2

Electrical Features

- High Efficiency
- Low Conduction and Switching Losses
- High Speed Field Stop IGBT
- SiC SBD for Boost Diode
- Built-in NTC for Temperature Monitoring

Mechanical Features

- Compact Size : F2 Package
- Soldering Pin
- Al₂O₃ Substrate with Low Thermal Resistance
- Pre-applied PCM (Phase Change Material)

Applications

- Solar Inverter

Related Materials

- AN-5077: Design Considerations for High Power Module (HPM)
- AN-4186: F1 and F2 Modules with Pre-applied Phase Change Material (PCM)

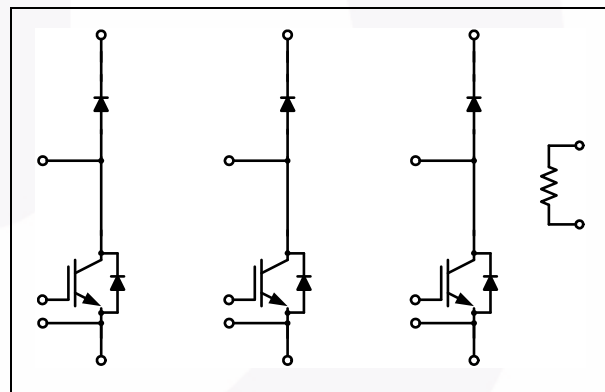

Internal Circuit Diagram

Package Marking and Ordering Information

Device	Device Marking	Package	PCM	Packing Type	Quantity / Tray
FPF2G120BF07AS	FPF2G120BF07AS	F2	X	Tray	14
FPF2G120BF07ASP	FPF2G120BF07ASP	F2	O	Tray	14

FPF2G120BF07ASP - F2, 3ch Boost module PCM and NTC

Absolute Maximum Ratings $T_C = 25^\circ\text{C}$ unless otherwise noted.

Symbol	Description	Condition	Rating	Units
Boost IGBT				
V_{CES}	Collector-Emitter Voltage		650	V
V_{GES}	Gate-Emitter Voltage		± 20	V
	Transient Gate-Emitter Voltage		± 25	V
I_C	Continuous Collector Current	$T_C = 80^\circ\text{C}, T_{Jmax} = 175^\circ\text{C}$	40	A
I_{CM}	Pulsed Collector Current	limited by T_{Jmax}	80	A
P_D	Maximum Power Dissipation		156	W
T_J	Operating Junction Temperature		- 40 to + 150	$^\circ\text{C}$
Protection Diode				
V_{RRM}	Peak Repetitive Reverse Voltage		650	V
I_F	Continuous Forward Current	$T_C = 80^\circ\text{C}, T_{Jmax} = 175^\circ\text{C}$	15	A
I_{FM}	Maximum Forward Current		30	A
I_{FSM}	Non-repetitive Peak Surge Current	60Hz Single Half-Sine Wave	150	A
I^2t - value	Surge Current Integral Value		93	A^2s
P_D	Maximum Power Dissipation		140	W
T_J	Operating Junction Temperature		- 40 to + 150	$^\circ\text{C}$
Boost Diode				
V_{RRM}	Peak Repetitive Reverse Voltage		650	V
I_F	Continuous Forward Current	$T_C = 80^\circ\text{C}, T_{Jmax} = 175^\circ\text{C}$	15	A
I_{FM}	Maximum Forward Current		30	A
I_{FSM}	Non-repetitive Peak Surge Current	60Hz Single Half-Sine Wave	120	A
I^2t - value	Surge Current Integral Value		60	A^2s
P_D	Maximum Power Dissipation		98	W
T_J	Operating Junction Temperature		- 40 to + 150	$^\circ\text{C}$
Module				
T_{STG}	Storage Temperature		- 40 to + 125	$^\circ\text{C}$
V_{ISO}	Isolation Voltage	AC 1 min.	2500	V
Iso_Material	Internal Isolation Material		Al_2O_3	-
T_{MOUNT}	Mounting Torque		2.0 to 5.0	N•m
Creepage	Terminal to Heat Sink		11.5	mm
	Terminal to Terminal		6.3	mm
Clearance	Terminal to Heat Sink		10.0	mm
	Terminal to Terminal		5.0	mm

Electrical Characteristics $T_C = 25^\circ\text{C}$ unless otherwise noted.

Symbol	Parameter	Conditions	Min.	Typ.	Max.	Units
Boost IGBT						
Off Characteristics						
BV_{CES}	Collector-Emitter Breakdown Voltage	$V_{GE} = 0\text{ V}, I_C = 1\text{ mA}$	650	-	-	V
I_{CES}	Collector Cut-off Current	$V_{CE} = V_{CES}, V_{GE} = 0\text{ V}$	-	-	250	μA
I_{GES}	Gate-Emitter Leakage Current	$V_{GE} = V_{GES}, V_{CE} = 0\text{ V}$	-	-	± 2	μA
On Characteristics						
$V_{GE(th)}$	Gate-Emitter Threshold Voltage	$V_{GE} = V_{CE}, I_C = 40\text{ mA}$	3.9	5.1	6.8	V
$V_{CE(sat)}$	Collector-Emitter Saturation Voltage	$I_C = 40\text{ A}, V_{GE} = 15\text{ V}$	-	1.55	2.2	V
		$I_C = 40\text{ A}, V_{GE} = 15\text{ V}, T_C = 125^\circ\text{C}$	-	1.85	-	V
R_{LEAD}	Lead Resistance of Pin to Chip	per Chip	-	3.3	-	$\text{m}\Omega$
Switching Characteristics						
$t_{d(on)}$	Turn-On Delay Time	$V_{CC} = 300\text{ V}$ $I_C = 40\text{ A}$ $V_{GE} = 15\text{ V}$ $R_G = 15\ \Omega$ Inductive Load $T_C = 25^\circ\text{C}$	-	24	-	ns
t_r	Rise Time		-	24	-	ns
$t_{d(off)}$	Turn-Off Delay Time		-	132	-	ns
t_f	Fall Time		-	17	-	ns
E_{ON}	Turn-On Switching Loss per Pulse		-	0.40	-	mJ
E_{OFF}	Turn-Off Switching Loss per Pulse		-	0.28	-	mJ
$t_{d(on)}$	Turn-On Delay Time	$V_{CC} = 300\text{ V}$ $I_C = 40\text{ A}$ $V_{GE} = 15\text{ V}$ $R_G = 15\ \Omega$ Inductive Load $T_C = 125^\circ\text{C}$	-	22	-	ns
t_r	Rise Time		-	27	-	ns
$t_{d(off)}$	Turn-Off Delay Time		-	148	-	ns
t_f	Fall Time		-	17	-	ns
E_{ON}	Turn-On Switching Loss per Pulse		-	0.59	-	mJ
E_{OFF}	Turn-Off Switching Loss per Pulse		-	0.37	-	mJ
Q_g	Total Gate Charge	$V_{CC} = 300\text{ V}, I_C = 40\text{ A}, V_{GE} = 15\text{ V}$	-	65	-	nC
$R_{\theta JC}$	Thermal Resistance of Junction to Case	per Chip	-	-	0.96	$^\circ\text{C/W}$
$R_{\theta CH}$	Thermal Resistance of Case to Heat sink	per Chip, $\lambda_{PCM} = 3.4\text{ W/mK}$	-	0.54	-	$^\circ\text{C/W}$
Protection Diode						
V_F	Diode Forward Voltage	$I_F = 15\text{ A}$	-	1.05	1.4	V
		$I_F = 15\text{ A}, T_C = 125^\circ\text{C}$	-	0.95	-	V
R_{LEAD}	Lead Resistance of Pin to Chip	per Chip	-	2.4	-	$\text{m}\Omega$
I_R	Reverse Leakage Current	$V_R = 650\text{ V}$	-	-	250	μA
$R_{\theta JC}$	Thermal Resistance of Junction to Case	per Chip	-	-	1.07	$^\circ\text{C/W}$
$R_{\theta CH}$	Thermal Resistance of Case to Heat sink	per Chip, $\lambda_{PCM} = 3.4\text{ W/mK}$	-	0.33	-	$^\circ\text{C/W}$
Boost Diode						
V_F	Diode Forward Voltage	$I_F = 15\text{ A}$	-	1.45	1.9	V
		$I_F = 15\text{ A}, T_C = 125^\circ\text{C}$	-	1.75	-	V
R_{LEAD}	Lead Resistance of Pin to Chip	per Chip	-	2.8	-	$\text{m}\Omega$
I_R	Reverse Leakage Current	$V_R = 650\text{ V}$	-	-	60	μA
I_{rr}	Reverse Recovery Current	$V_R = 300\text{ V}, I_F = 15\text{ A},$ $di/dt = 1390\text{ A/us},$ $T_C = 25^\circ\text{C}$	-	9.2	-	A
Q_C	Total Capacitive Charge	$V_R = 300\text{ V}, I_F = 15\text{ A},$ $di/dt = 1390\text{ A/us},$ $T_C = 125^\circ\text{C}$	-	60	-	nC
E_{rec}	Reverse Recovery Energy		-	4.9	-	μJ
I_{rr}	Reverse Recovery Current		-	9.2	-	A
Q_C	Total Capacitive Charge	$V_R = 300\text{ V}, I_F = 15\text{ A},$ $di/dt = 1390\text{ A/us},$ $T_C = 125^\circ\text{C}$	-	65	-	nC
E_{rec}	Reverse Recovery Energy		-	4.9	-	μJ
$R_{\theta JC}$	Thermal Resistance of Junction to Case	per Chip	-	-	1.52	$^\circ\text{C/W}$
$R_{\theta CH}$	Thermal Resistance of Case to Heat sink	per Chip, $\lambda_{PCM} = 3.4\text{ W/mK}$	-	0.18	-	$^\circ\text{C/W}$

Electrical Characteristics $T_C = 25^\circ\text{C}$ unless otherwise noted.

Symbol	Parameter	Conditions	Min.	Typ.	Max.	Units
NTC (Thermistor)						
R_{NTC}	Rated Resistance	$T_C = 25^\circ\text{C}$	-	10	-	$\text{k}\Omega$
		$T_C = 100^\circ\text{C}$	-	936	-	Ω
	Tolerance	$T_C = 25^\circ\text{C}$	-3	-	+3	%
P_D	Power Dissipation	$T_C = 25^\circ\text{C}$	-	-	20	mW
B_{Value}	B-Constant	$B_{25/50}$	-	3450	-	K
		$B_{25/100}$	-	3513	-	K

Typical Performance Characteristics

Fig 1. Typical Output Characteristics - IGBT

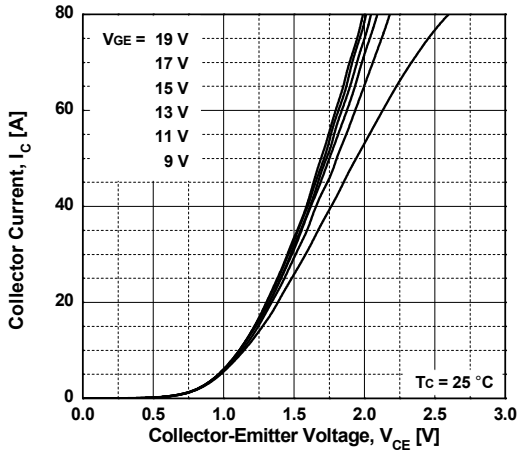

Fig 2. Typical Output Characteristics - IGBT

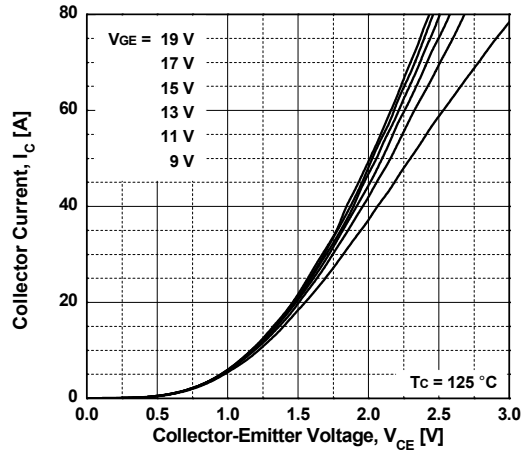

Fig 3. Typical Saturation Voltage Characteristics - IGBT

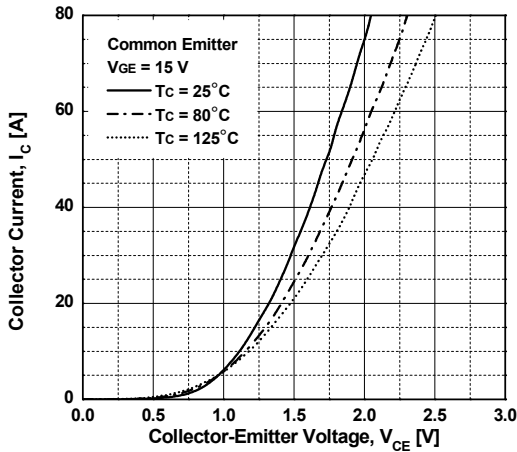

Fig 4. Switching Loss vs. Collector Current - IGBT

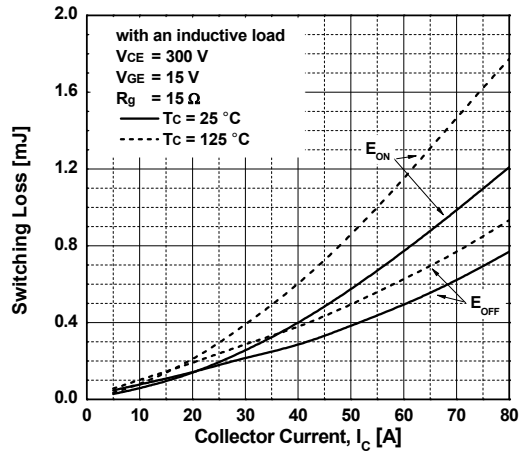

Fig 5. Switching Loss vs. Gate Resistance - IGBT

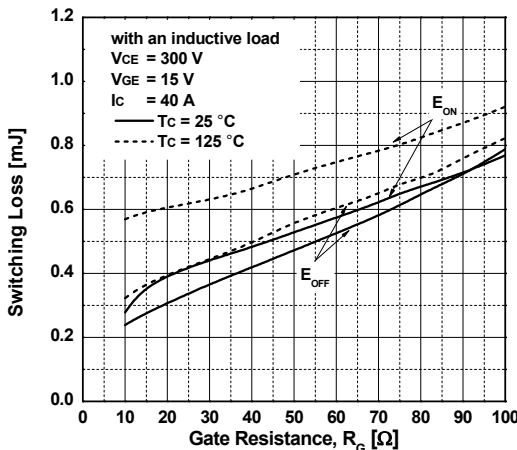
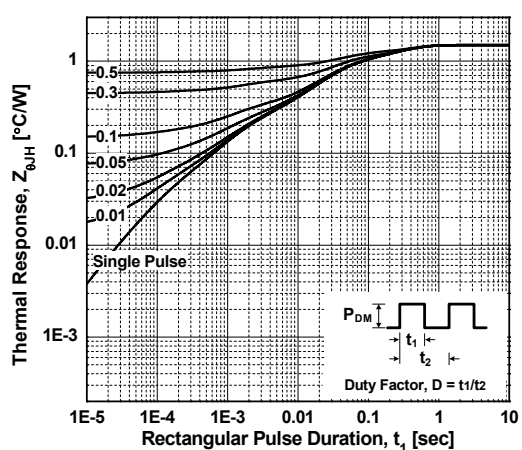

Fig 6. Transient Thermal Impedance - IGBT



Typical Performance Characteristic

Fig 7. Typical Forward Voltage Drop - Protection Diode

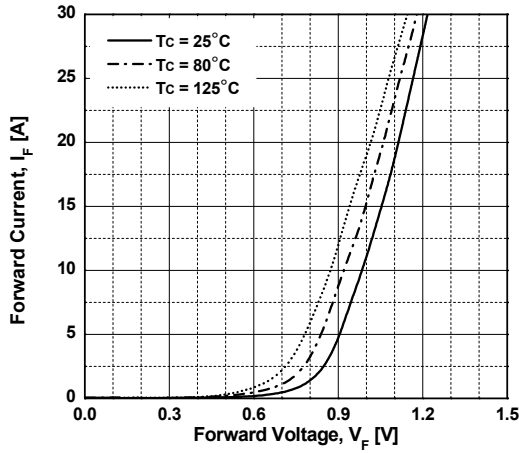

Fig 8. Transient Thermal Impedance - Protection Diode

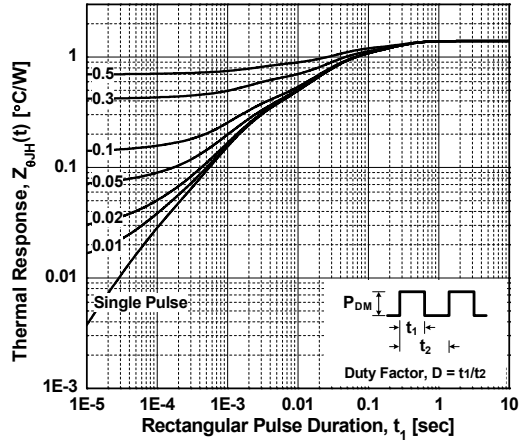

Fig 9. Typical Forward Voltage Drop - Boost Diode

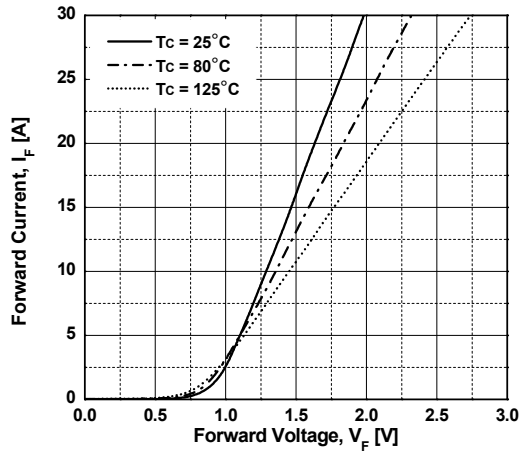

Fig 10. Reverse Recovery Energy vs. Forward Current - Boost Diode

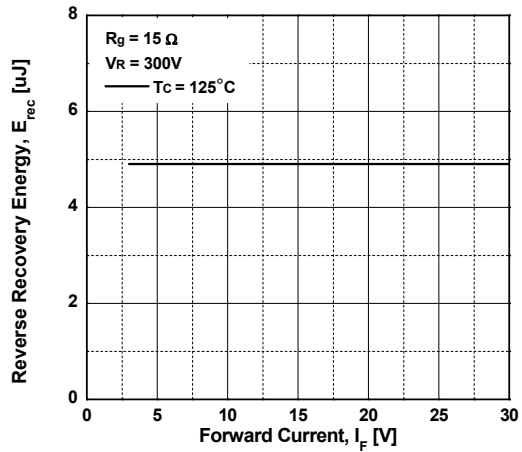

Fig 11. Reverse Recovery Energy vs. Gate Resistance - Boost Diode

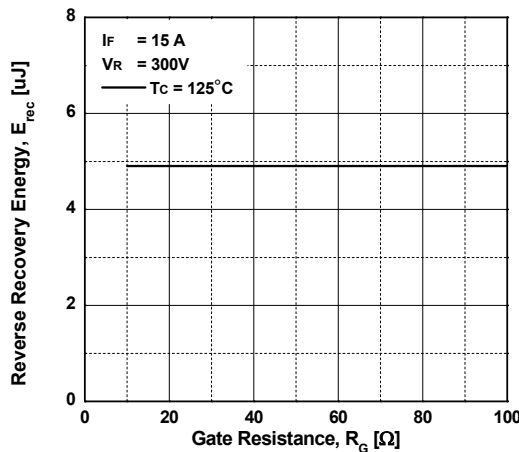
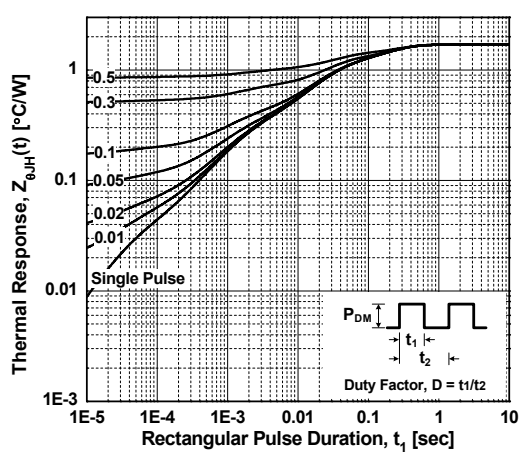
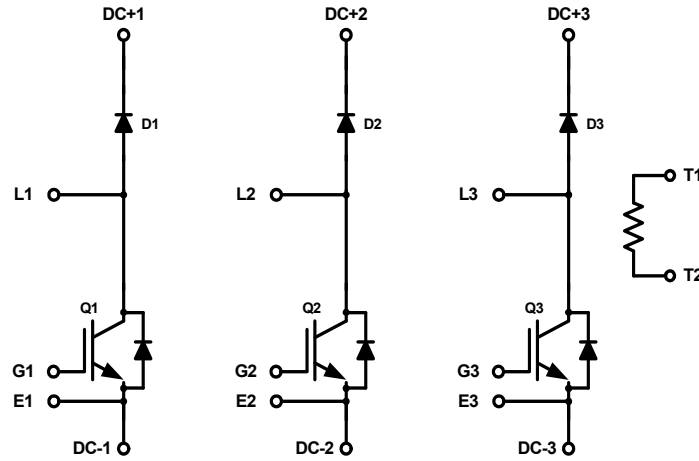

Fig 12. Transient Thermal Impedance - Boost Diode



Internal Circuit Diagram



Package Outlines [mm]

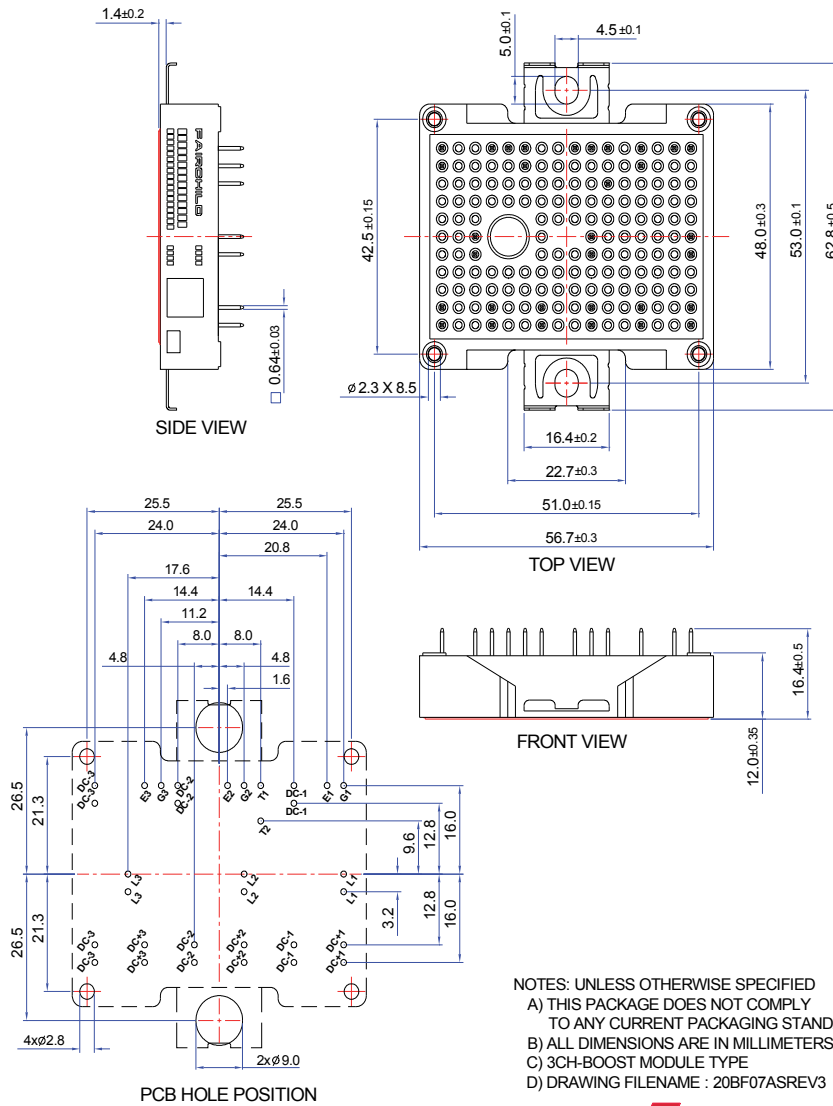

NOTES: UNLESS OTHERWISE SPECIFIED
 A) THIS PACKAGE DOES NOT COMPLY TO ANY CURRENT PACKAGING STANDARD
 B) ALL DIMENSIONS ARE IN MILLIMETERS
 C) 3CH-BOOST MODULE TYPE
 D) DRAWING FILENAME : 20BF07ASREV3





- PIN-GRID 3.2mm
 - TOLERANCE OF PCB HOLE PATTERN $\pm \varnothing 0.1$



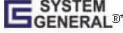

TRADEMARKS

The following includes registered and unregistered trademarks and service marks, owned by Fairchild Semiconductor and/or its global subsidiaries, and is not intended to be an exhaustive list of all such trademarks.

- | | | | |
|--|--|---|---|
| AccuPower™ | F-PFS™ | OPTOPLANAR® |  SYSTEM GENERAL® |
| AttitudeEngine™ | FRFET® |  ® | TinyBoost® |
| Awinda® | Global Power Resource™ | Power Supply WebDesigner™ | TinyBuck® |
| AX-CAP®* | GreenBridge™ | PowerTrench® | TinyCalc™ |
| BitSiC™ | Green FPS™ | PowerXS™ | TinyLogic® |
| Build it Now™ | Green FPS™ e-Series™ | Programmable Active Droop™ | TINYOPTO™ |
| CorePLUS™ | Gmax™ | QFET® | TinyPower™ |
| CorePOWER™ | GTO™ | QS™ | TinyPWM™ |
| CROSSVOLT™ | IntelliMAX™ | Quiet Series™ | TinyWire™ |
| CTL™ | ISOPLANAR™ | RapidConfigure™ | TransiC™ |
| Current Transfer Logic™ | Making Small Speakers Sound Louder and Better™ |  ™ | TriFault Detect™ |
| DEUXPEED® | MegaBuck™ | Saving our world, 1mW/W/kW at a time™ | TRUECURRENT®* |
| Dual Cool™ | MICROCOUPLER™ | SignalWise™ | μSerDes™ |
| EcoSPARK® | MicroFET™ | SmartMax™ |  SerDes™ |
| EfficientMax™ | MicroPak™ | SMART START™ | UHC® |
| ESBC™ | MicroPak2™ | Solutions for Your Success™ | Ultra FRFET™ |
|  Fairchild® | MillerDrive™ | SPM® | UniFET™ |
| Fairchild Semiconductor® | MotionMax™ | STEALTH™ | VCX™ |
| FACT Quiet Series™ | MotionGrid® | SuperFET® | VisualMax™ |
| FACT® | MTI® | SuperSOT™-3 | VoltagePlus™ |
| FAST® | MTX® | SuperSOT™-6 | XS™ |
| FastvCore™ | MVN® | SuperSOT™-8 | Xsens™ |
| FETBench™ | mWSaver® | SupreMOS® | 仙童™ |
| FPS™ | OptoHi™ | SyncFET™ | |
| | OPTOLOGIC® | Sync-Lock™ | |

* Trademarks of System General Corporation, used under license by Fairchild Semiconductor.

DISCLAIMER

FAIRCHILD SEMICONDUCTOR RESERVES THE RIGHT TO MAKE CHANGES WITHOUT FURTHER NOTICE TO ANY PRODUCTS HEREIN TO IMPROVE RELIABILITY, FUNCTION, OR DESIGN. TO OBTAIN THE LATEST, MOST UP-TO-DATE DATASHEET AND PRODUCT INFORMATION, VISIT OUR WEBSITE AT [HTTP://WWW.FAIRCHILDSEMI.COM](http://www.fairchildsemi.com). FAIRCHILD DOES NOT ASSUME ANY LIABILITY ARISING OUT OF THE APPLICATION OR USE OF ANY PRODUCT OR CIRCUIT DESCRIBED HEREIN; NEITHER DOES IT CONVEY ANY LICENSE UNDER ITS PATENT RIGHTS, NOR THE RIGHTS OF OTHERS. THESE SPECIFICATIONS DO NOT EXPAND THE TERMS OF FAIRCHILD'S WORLDWIDE TERMS AND CONDITIONS, SPECIFICALLY THE WARRANTY THEREIN, WHICH COVERS THESE PRODUCTS.

LIFE SUPPORT POLICY

FAIRCHILD'S PRODUCTS ARE NOT AUTHORIZED FOR USE AS CRITICAL COMPONENTS IN LIFE SUPPORT DEVICES OR SYSTEMS WITHOUT THE EXPRESS WRITTEN APPROVAL OF FAIRCHILD SEMICONDUCTOR CORPORATION.

As used herein:

1. Life support devices or systems are devices or systems which, (a) are intended for surgical implant into the body or (b) support or sustain life, and (c) whose failure to perform when properly used in accordance with instructions for use provided in the labeling, can be reasonably expected to result in a significant injury of the user.
2. A critical component in any component of a life support, device, or system whose failure to perform can be reasonably expected to cause the failure of the life support device or system, or to affect its safety or effectiveness.

ANTI-COUNTERFEITING POLICY

Fairchild Semiconductor Corporation's Anti-Counterfeiting Policy. Fairchild's Anti-Counterfeiting Policy is also stated on our external website, www.fairchildsemi.com, under Sales Support.

Counterfeiting of semiconductor parts is a growing problem in the industry. All manufacturers of semiconductor products are experiencing counterfeiting of their parts. Customers who inadvertently purchase counterfeit parts experience many problems such as loss of brand reputation, substandard performance, failed applications, and increased cost of production and manufacturing delays. Fairchild is taking strong measures to protect ourselves and our customers from the proliferation of counterfeit parts. Fairchild strongly encourages customers to purchase Fairchild parts either directly from Fairchild or from Authorized Fairchild Distributors who are listed by country on our web page cited above. Products customers buy either from Fairchild directly or from Authorized Fairchild Distributors are genuine parts, have full traceability, meet Fairchild's quality standards for handling and storage and provide access to Fairchild's full range of up-to-date technical and product information. Fairchild and our Authorized Distributors will stand behind all warranties and will appropriately address any warranty issues that may arise. Fairchild will not provide any warranty coverage or other assistance for parts bought from Unauthorized Sources. Fairchild is committed to combat this global problem and encourage our customers to do their part in stopping this practice by buying direct or from authorized distributors.

PRODUCT STATUS DEFINITIONS

Definition of Terms

Datasheet Identification	Product Status	Definition
Advance Information	Formative / In Design	Datasheet contains the design specifications for product development. Specifications may change in any manner without notice.
Preliminary	First Production	Datasheet contains preliminary data; supplementary data will be published at a later date. Fairchild Semiconductor reserves the right to make changes at any time without notice to improve design.
No Identification Needed	Full Production	Datasheet contains final specifications. Fairchild Semiconductor reserves the right to make changes at any time without notice to improve the design.
Obsolete	Not In Production	Datasheet contains specifications on a product that is discontinued by Fairchild Semiconductor. The datasheet is for reference information only.

Rev. I74

ON Semiconductor and  are trademarks of Semiconductor Components Industries, LLC dba ON Semiconductor or its subsidiaries in the United States and/or other countries. ON Semiconductor owns the rights to a number of patents, trademarks, copyrights, trade secrets, and other intellectual property. A listing of ON Semiconductor's product/patent coverage may be accessed at www.onsemi.com/site/pdf/Patent-Marking.pdf. ON Semiconductor reserves the right to make changes without further notice to any products herein. ON Semiconductor makes no warranty, representation or guarantee regarding the suitability of its products for any particular purpose, nor does ON Semiconductor assume any liability arising out of the application or use of any product or circuit, and specifically disclaims any and all liability, including without limitation special, consequential or incidental damages. Buyer is responsible for its products and applications using ON Semiconductor products, including compliance with all laws, regulations and safety requirements or standards, regardless of any support or applications information provided by ON Semiconductor. "Typical" parameters which may be provided in ON Semiconductor data sheets and/or specifications can and do vary in different applications and actual performance may vary over time. All operating parameters, including "Typicals" must be validated for each customer application by customer's technical experts. ON Semiconductor does not convey any license under its patent rights nor the rights of others. ON Semiconductor products are not designed, intended, or authorized for use as a critical component in life support systems or any FDA Class 3 medical devices or medical devices with a same or similar classification in a foreign jurisdiction or any devices intended for implantation in the human body. Should Buyer purchase or use ON Semiconductor products for any such unintended or unauthorized application, Buyer shall indemnify and hold ON Semiconductor and its officers, employees, subsidiaries, affiliates, and distributors harmless against all claims, costs, damages, and expenses, and reasonable attorney fees arising out of, directly or indirectly, any claim of personal injury or death associated with such unintended or unauthorized use, even if such claim alleges that ON Semiconductor was negligent regarding the design or manufacture of the part. ON Semiconductor is an Equal Opportunity/Affirmative Action Employer. This literature is subject to all applicable copyright laws and is not for resale in any manner.

PUBLICATION ORDERING INFORMATION

LITERATURE FULFILLMENT:

Literature Distribution Center for ON Semiconductor
19521 E. 32nd Pkwy, Aurora, Colorado 80011 USA
Phone: 303-675-2175 or 800-344-3860 Toll Free USA/Canada
Fax: 303-675-2176 or 800-344-3867 Toll Free USA/Canada
Email: orderlit@onsemi.com

N. American Technical Support: 800-282-9855 Toll Free
USA/Canada
Europe, Middle East and Africa Technical Support:
Phone: 421 33 790 2910
Japan Customer Focus Center
Phone: 81-3-5817-1050

ON Semiconductor Website: www.onsemi.com
Order Literature: <http://www.onsemi.com/orderlit>
For additional information, please contact your local
Sales Representative